

Odyssey Series

Installation Manual

INS154-7

Content

- 1.0 Installation** 3
 - 1.1 Accessing The Unit 3
 - 1.2 Mounting the Unit 4
 - 1.3 Adjusting Tamper Sensitivity 4
 - 1.4 Wiring The Unit 5
 - 1.5 Grade 3 Wiring 6
 - 1.6 Installing Multiple Units 8
 - 1.7 Commissioning 9
- 2.0 Servicing** 10
- 3.0 Safety** 12
- 4.0 Technical Specification** 13
- 5.0 Standards** 15
- 6.0 Warranty** 16

1.0 Installation

1.1 Accessing The Unit

Premier Elite Odyssey 1/ Premier Odyssey 1E

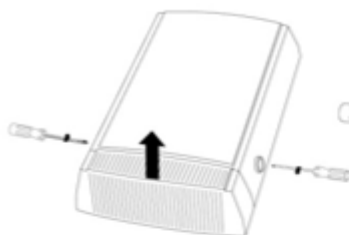

Premier Elite Odyssey 2/ Premier Odyssey 2E

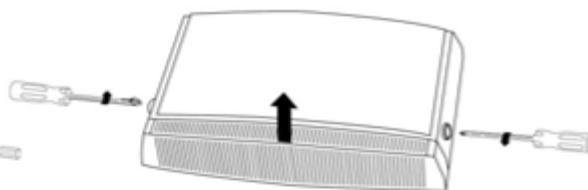

Premier Elite Odyssey 3 & 3M/ Premier Odyssey 3E

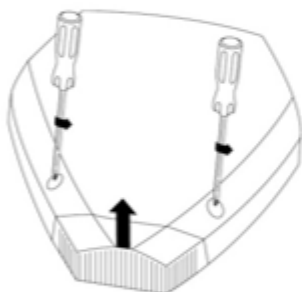

Premier Elite Odyssey 4/ Premier Odyssey 4E

Screw retained
in backplate.

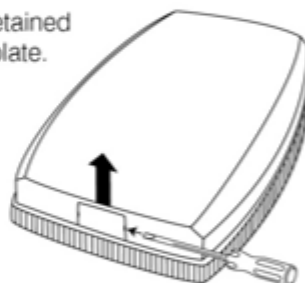

Premier Elite Odyssey 5/ Premier Odyssey 5E

Screw retained
in backplate.



Premier Elite Odyssey 5C/ Premier Odyssey 5EC

Screw retained in lid.



1.2 Mounting the Unit

Select a suitable position to mount the unit, which satisfies the following criteria:

1. Highly prominent for maximum deterrence
2. Additional shelter (e.g. under the eaves) is an advantage
3. High enough to be out of normal reach to deter tampering
4. Safe ladder access
5. Good cable access

In addition to the corner screw fixing points, the unit also has a central keyhole to simplify mounting and aid levelling.

Four screws and wall plugs are required for mounting the backplate to an even surface. An additional screw may be required to provide wall tamper by fitting through the screw hole next to the dual tamper microswitch. In doing so, care must be taken to leave the screw head slightly proud to ensure that the microswitch remains level and closes correctly when the outer cover is fitted.



For maximum weatherproofing the unit should be flat to the wall.

1.3 Adjusting Tamper Sensitivity

Some Texecom external sounder models now include a patented* tamper adjustment feature. If greater wall/lid tamper sensitivity is required, the microswitch position can be adjusted by loosening the locking screw and altering the orientation of the microswitch as shown.

* *Patent pending*



1.4 Wiring The Unit

Connect the unit to the control panel as follows:

A (12V) Positive Supply	Permanent	T (Test)*	Test input for enabling remote test via Maintex or Wintex, or any supporting panel.
B (BELL) Applied Output to Activate Siren	Negative	Tamper Relay*	Negative Removed on Tamper Input, and reports Tamper when there is a power loss to the sounder. (
C (TAMP) Removed on Tamper Input	Negative	Fault Relay*	Reports Faults from the sounder
D (0V) Negative Supply	Permanent	<small>NOTE</small> * Premier Elite Sounders only	
S (STRB) Output to Activate Strobe	Negative Applied		

Although the unit has been designed to be compatible with a wide range of control panels, for optimum performance, it is highly recommended that the unit should be used with Texecom's range of control panels.

For safety reasons, each Texecom sounder and strobe unit incorporates a unique patented engineer Hold-Off mode. This mode prevents the unit from self-activating during installation and maintenance, thereby allowing only bona fide engineers

access to the unit without any loss of tamper protection.

When connecting the unit to the control panel, it is recommended that wiring should be connected to the unit **first** and the control panel **second**. The unit should then be initially powered from the control panel. If the tamper circuit is open the siren will sound for 5 seconds after which it will automatically enter Hold-Off mode and disable Self-Activate (S/A) on tamper. This will prevent the unit from self-activating as long as the tamper circuit remains open. An open tamper circuit is indicated by only the left-hand side LED flashing. Connect the battery either using the jumper included on some models or by moving the red battery wire from the “N/C” (No Connect) terminal to the “Battery +” terminal. Fit the outer cover and secure with the M6 screw(s) provided.

When the outer cover is replaced and the tamper circuit is closed, the LEDs will alternate rapidly, confirming that the tamper circuit is secure and signalling that S/A on tamper will be re-enabled within 2 minutes, after which the LEDs will alternate slowly to signal normal operation. If the tamper circuit is re-opened within the 2 minute period, then Hold-Off mode will be restored.



If the unit is powered up with the tamper circuit closed it will NOT sound for 5 seconds and will NOT enter Hold-Off mode. In order to disable the S/A function, before the cover is removed, Hold-Off mode should be invoked as for servicing ([see Section 0](#)).



For safety reasons the strobe is disabled during Hold-Off mode. Hold-Off mode is immediately cancelled when the sounder is activated from the control panel.

1.5 Grade 3 Wiring

To meet the requirements of EN50131-1 & EN50131-4 additional wiring is required at Grade 3 to monitor the status of the battery, the supply voltage and the integrity of the trigger wire. The two diagrams below show wiring configurations for Texecom control panels, and other manufacturers. Please check the Control Panel installation manual for any programming requirements relating to Grade 3 installations.

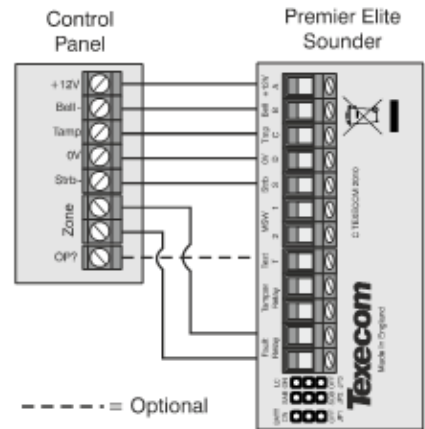
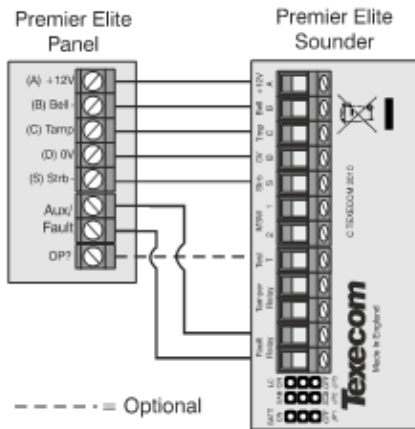

NOTE To comply with EN50131 requirements at Grade 3 the bell trigger should be pulled high by the control equipment. When connecting to some third party systems, or using a relay output a 1kΩ resistor should be connected between the bell trigger and the positive supply at the control panel.

Test Input

The test input can be used to invoke a remote sounder test, this performs the same functions as the self test which is carried out once every 24 hours. To invoke the test the input must be placed at 0V for a minimum of 60s, during this time the Fault relay will open to signal the test is in progress. On completion of a successful test the Fault relay will close, if the test fails the relay will stay open.

Optional “Battery First” Connection Method

Hold-Off mode automatically cancels when both the tamper circuit is closed and power is supplied from the control panel. This allows installation engineers to power the unit from the internal battery and fit the outer cover, knowing that the unit cannot self-activate until after power has been supplied from the control panel.

- NOTE** If the tamper circuit is closed and the unit is powered by the battery only, the right LED will flash quickly to signal that the unit cannot self-activate until power has been supplied from the control panel.
- ⚠** Prolonged “battery first” connection without power from the control panel may cause permanent damage to the internal battery. *Texecom*

recommend that the unit is initially powered on battery only for no longer than 24 hours.

1.6 Installing Multiple Units

The following diagram illustrates how to wire multiple units together:

Remove tamper wire from MSW 2 on first unit and connect to spare core. On second unit connect spare core into MSW 1.

For Grade 3 installations using multiple units the Fault relays should be wired in series.

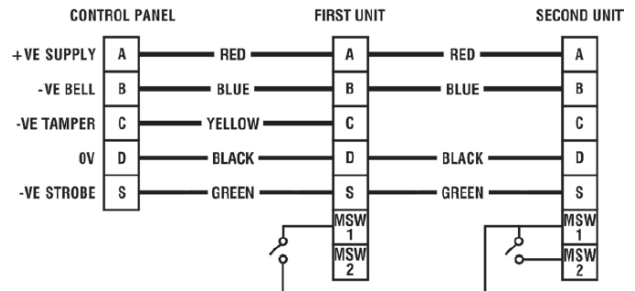

If the first unit is opened it will self-activate and a tamper will be signalled to the control panel. If the second unit is opened both units will self-activate and a tamper will be signalled to the control panel.

If more than one unit is connected to an installation, the current demand may exceed the rated current output of the control panel. This can be avoided by selecting Low Current (LC) or SCB mode on one or more of the connected units.

Low Current Mode

Low current mode* allows the sounder current draw from the control panel to be reduced whilst maintaining significant alarm volume. To select low current mode, ensure the SAB/SCB jumper is in the SAB position and move the LC jumper to the Low Current on position. Details on current draw can be found in the technical specification ([section 4](#)).



* *Not available on all models*

SCB Mode

In SCB mode the unit draws the majority of its sounding current from the built-in



battery rather than from the control panel. Although volume is somewhat reduced, lowering the current demand on the control panel will enable the connection of additional sounder units.

To select SCB Mode, the unit should first be powered from the built-in battery by either using the jumper included on some models or by connecting the red battery wire from the “N/C” (No Connect) terminal to the “Battery +” terminal. The unit will automatically enter Hold-Off mode to disable Self-Activate (S/A) on tamper, this will prevent the unit from self-activating until both the tamper circuit is closed and power is supplied from the control panel. Move the SAB/SCB jumper to the SCB position before the unit is connected to the control panel.

-  *If the tamper circuit is closed and the unit is powered by the battery only, the right LED will flash quickly to signal that the unit cannot self-activate until power has been supplied from the control panel.*
-  *When selecting SCB mode the battery must be connected before power is supplied from the control panel. If a unit is powered from a control panel with SCB mode selected but without the battery connected, the unit will not operate correctly due to the lack of power provided.*
-  *The built-in battery will only be partially charged on delivery.*

1.7 Commissioning

Most control panels have a method of testing the siren and strobe, which should be utilised for final testing. Failing this, simply arm the system and cause an alarm to confirm correct operation. Temporarily disconnect the positive supply to the unit at the control panel to confirm that the sounder self-activates.



-  *The strobe does not self-activate.*
-  *Some control panels have an option to select the sounder cut-off time. The unit will sound for either 15 minutes or for the panel cut-off time, whichever is the shorter.*

Please note, it cannot be guaranteed that the battery is fully charged on installation. When commissioning, the unit may require to be powered from the control panel for a period of time before the battery is sufficiently charged for self-activation.

2.0 Servicing

**CAUTION: BEFORE OPENING THE COVER ALLOW AT
LEAST 3 MINUTES AFTER THE LAST STROBE FLASH**

Most control panels have a method of testing the siren and strobe, which should be utilised. Failing this, simply arm the system and cause an alarm to confirm correct operation. Temporarily disconnect the positive supply to the unit at the control panel to confirm that the sounder self-activates.

-  *The strobe does not self-activate.*
-  *Some control panels have an option to select the sounder cut-off time. The unit will sound for either 15 minutes or for the panel cut-off time, whichever is the shorter.*

For safety reasons if it is necessary to inspect the unit, the Self-Activate (S/A) function should be disabled before the cover is opened or remote power removed. This is achieved by using the unit's unique patented engineer Hold-Off mode. This is invoked by activating and de-activating the strobe three times within 30 seconds. Most control panels have a method of testing the strobe, which should be utilised. Failing this the strobe can be manually activated by connecting the S (STRB) wire to 0V at the control panel. Hold-Off mode is shown to be active with the tamper circuit secure by the right LED only flashing.



If the tamper circuit is not opened or remote power not removed, then Hold-Off mode will automatically start to cancel after 15 minutes, indicated by the LEDs alternating rapidly to signal that S/A on tamper and remote power loss will be re-enabled within a further 2 minutes.

Once the outer cover is removed the left LED only will flash to indicate that the tamper circuit is open. If remote power is removed, and the tamper circuit is left closed, the right LED will flash rapidly to indicate that the unit is on standby battery power.

When the tamper circuit is closed or remote power re-applied, the LEDs will alternate rapidly, confirming that the tamper circuit is secure, remote power is

present and signalling that the self activating S/A function will be re-enabled within 2 minutes, after which the LEDs will alternate slowly to signal normal operation. If the tamper circuit is re-opened or remote power removed within the 2 minute period, then Hold-Off mode will be restored.

Summary of LED States	
Slow flashing LEDs	Normal operation
Left LED flashing only	Hold-Off active, tamper circuit open
Right LED flashing only	Hold-Off active, tamper circuit closed
Fast flashing Right LED	Hold-Off active, remote power removed
Fast flashing LEDs	Hold-Off active but will cancel within 2 minutes



-  *If Hold-Off mode is invoked but the tamper circuit is not opened or remote power is not removed within 15 minutes then Hold-Off will automatically start to cancel, indicated by the LEDs alternating rapidly for a further 2 minutes.*
-  *For safety reasons the strobe is disabled during Hold-Off mode.*
-  *Hold-Off mode is immediately cancelled when the sounder is activated from the control panel unless the system is powered down.*

3.0 Safety

INSTALLATION AND MAINTENANCE BY
QUALIFIED SERVICE PERSONNEL ONLY

All strobes produce hazardous voltages. However, the unit includes dual circuit safety interlocks. When the strobe is de-activated it invokes a final flash to discharge the high voltage. Back-up circuitry guarantees discharge of the high voltage within 3 minutes.

For your own safety be sure to observe the following precautions when installing and servicing the unit:

1. **NEVER** remove the cover when the strobe is flashing.
2. **WAIT** 3 Minutes after the strobe stops flashing before removing the cover.
3. **AVOID** touching the part of the PCB labelled "Warning High Voltage"
 -  *The unit incorporates software which disables the strobe whilst the tamper switch remains open. This is a safety feature and cannot be disabled.*
 -  *The piezo drive produces high voltages when the siren is sounding. While not directly hazardous, these voltages will cause discomfort and should be avoided, particularly when using tools or a ladder.*
 -  *The piezo transformer TF1 and surrounding components will be hot during and after sounding. While not directly hazardous, contact when hot will cause discomfort and should be avoided, particularly when using tools or a ladder.*

Failure to observe the following precautions regarding the battery could lead to the danger of heating, ignition or explosion:

- Do not throw into a fire
- Do not over-charge
- Do not short-circuit
- Replace only with the same or equivalent type
- Do not heat
- Do not reverse charge
- Do not disassemble

- ⚠ Always observe local regulations when disposing of a battery.
- ⚠ Plastic bags can suffocate - always dispose of packaging carefully.

4.0 Technical Specification

Environmental		Electrical			
Volume (SAB mode at 13.7VDC)		Supply Voltage:	12-16 VDC (13.7 nominal)		
<i>E Models:</i>	109dB Peak at 1m (A Weighting, 90°)	Current Drain (typical at 13.7VDC)			
<i>Non E Models</i>	115dB Peak at 1m (A Weighting, 90°)	Quiescent:	18mA		
Acoustic Output	Varying Sound Output	Strobe:	100mA		
Cut-Off Time:	15 minutes	Sounder	SAB	LC	
Waterproof Coating:	Conformal	<i>E Models:</i>	285mA	160mA	
Environmental Protection		<i>Non E Models:</i>	405mA	190mA	
<i>E Models:</i>	IP44	Standby Battery			
<i>Non E Models</i>	IP65	Type:	NiMh Stack		

Operating Temperature :	-25°C (-13°F) to +55°C (+131°F)	Voltage:	7.2VDC (nominal)		
Storage Temperature :	-25°C (-13°F) to +60°C (+140°F)	Capacity:	250mAh		
EMC Environment:	Residential / Commercial /Light Industrial / Industrial	Flash Tube:	1Ws Xenon		
		Flash Rate:	1Hz (typical) *		
		Discharge Time (60VDC):	180 seconds		
		Comfort LEDs			
		Brightness:	100mcd (typical)		
		Flash Rate (tamper secure):	1Hz alternating (typical)		

* The flash rate will reduce to 0.125Hz after flashing for one hour (1 flash every 8 seconds). This is a software feature to reduce power consumption and cannot be disabled.

-  *Total alarm current = Quiescent + Strobe + Sounder current.*

Physical

Material		Packed Weight	
3M	3mm polycarbonate 1.5mm galvanised steel	1, 3, 4 & 5	1250g (44oz) approx.

<i>All other models</i>	3mm polycarbonate	<i>1E,3E,4E,& 5E:</i>	
Tamper Detection		<i>2 & 2E:</i>	1600g (56oz) approx.
<i>1, 2, 3, 4, 5</i>	Wall, screw and lid	<i>3M:</i>	3000g (106oz) approx.
<i>3M</i>	Wall, lid and internal steel cover	<i>5C & 5EC</i>	950g (34oz) approx.
<i>All other models</i>	Wall and lid		
Dimensions (h x w x d)			
<i>1 &1E:</i>	318mm x 201mm x 66.5mm		
<i>2 &2E:</i>	242mm x 382mm x 76mm		
<i>3,3E & 3M:</i>	315mm x 306mm x 78mm		
<i>4 &4E:</i>	310mm x 196mm x 58.5mm		
<i>5 &5E:</i>	284 mm x 256 mm x 68 mm		
<i>5C & 5EC:</i>	189 mm x 186 mm x 60 mm		

5.0 Standards



Texecom declares that this product complies with the requirements of the

following directives:

- 2004/108/EC EMC Directive
- 2006/95/EC LVD Directive
- 2011/65/EU RoHS Directive

The product therefore meets all the requirements to enable it to be CE marked.

Weee Directive: 2012/19/EU (WEEE directive): Products marked with this symbol cannot be disposed of as unsorted municipal waste in the European Union. For proper recycling, return this product to your local supplier upon the purchase of equivalent new equipment, or dispose of it at designated collection points. For more information see: www.recyclethis.info.

These product are Type B Moveable devices and is suitable for use in systems designed to comply with EN 50131-1, EN50131-4 and PD6662 at Grade 2 & 3 and Environmental Class IV. All E Models are Grade 2 and all non E Models are Grade 3.

6.0 Warranty

All Texecom products are designed for reliable, trouble-free operation. Quality is carefully monitored by extensive computerised testing. As a result the *Premier Odyssey 1E, 2E, 3E, 4E, 5E* and *5E Compact* are covered by a two year warranty against defects in material or workmanship (details on request).

The *Premier Elite Odyssey 1, 2, 3, 4, 5*, and *5 Compact* are covered by a five year warranty.

Because the *Premier & Premier Elite Odyssey Series* are not complete alarm systems but only a part thereof, Texecom cannot accept responsibility or liability for any damages whatsoever based on a claim that a unit failed to function correctly. Due to our policy of continuous improvement Texecom reserve the right to change specification without prior notice.

Odyssey is a trademark of Texecom Ltd.

Premier & Premier Elite are trademarks of Texecom Ltd

