

4 MP IR Varifocal Dome Network Camera

DarkFighter



▪ DeepinView^{series}

- High quality imaging with 4 MP resolution
- Excellent low-light performance via DarkFighter technology
- Clear imaging against strong back light due to 140 dB WDR technology
- Efficient H.265+ compression technology to save bandwidth and storage
- 5 streams to meet a wide variety of applications
- Water and dust resistant (IP67) and vandal proof (IK10)
- Anti-IR reflection bubble guarantees image quality



▪ **Function**

Face Recognition

With embedded deep learning based algorithms, the camera is able to give the best shot of a target face through detecting, tracking, capturing, grading and selecting. The camera captures the face and outputs the features, such as gender, age, and expression. The camera uses face exposure function to dynamically adjust face area exposure of captures and ensures high face picture quality.

Perimeter Protection

With embedded deep learning based target detection and classification algorithms, the camera carries out the duty of perimeter protection, monitoring the actions of line crossing, intrusion, region entrance, and region exiting. The algorithms greatly filter out the mistaken alarm caused by the interference of leaves, lights, animal, flag, etc.

Multi-Target-Type Recognition

With the embedded deep learning algorithms, the camera detects and captures the face, human body, vehicle in the specified region and outputs the features, such as gender, age, top color, and vehicle type.

▪ Specification

Camera	
Image Sensor	1/1.8" Progressive Scan CMOS
Max. Resolution	2560 × 1440
Min. Illumination	Color: 0.0005 Lux @ (F1.2, AGC ON); B/W: 0.0001 Lux @ (F1.2, AGC ON), 0 Lux with IR
Shutter Time	1 s to 1/100,000 s
Day & Night	IR cut filter Blue glass module to reduce ghost phenomenon
Angle Adjustment	Pan: 0° to 355°, tilt: 0° to 75°, rotate: 0° to 355°
Lens	
Focal Length & FOV	2.8 to 12 mm, horizontal FOV: 114.5° to 41.8°, vertical FOV: 59.3° to 23.6°, diagonal FOV: 141.1° to 48° 8 to 32 mm, horizontal FOV: 42.5° to 15.1°, vertical FOV: 23.3° to 8.64°, diagonal FOV: 49.6° to 17.3°
Focus	Auto, semi-auto, manual
Iris Type	P-iris
Aperture	2.8 to 12 mm: F1.2 to F2.5 8 to 32 mm: F1.7 to F1.73
Illuminator	
IR Wavelength	850 nm
Supplement Light Type	IR
Smart Supplement Light	Yes
Supplement Light Range	2.8 to 12 mm: 30 m 8 to 32 mm: 50 m
Video	
Main Stream	50 Hz: 50 fps (2560 × 1440, 1920 × 1080, 1280 × 720) 60 Hz: 60 fps (2560 × 1440, 1920 × 1080, 1280 × 720)
Sub-Stream	50 Hz: 25 fps (704 × 480, 640 × 480) 60 Hz: 30 fps (704 × 480, 640 × 480)
Third Stream	50 Hz: 25 fps (1920 × 1080, 1280 × 720, 704 × 480, 640 × 480) 60 Hz: 30 fps (1920 × 1080, 1280 × 720, 704 × 480, 640 × 480)
Fourth Stream	50 Hz: 25 fps (704 × 480, 640 × 480) 60 Hz: 30 fps (704 × 480, 640 × 480)
Fifth Stream	50 Hz: 25 fps (704 × 480, 640 × 480) 60 Hz: 30 fps (704 × 480, 640 × 480)
Video Compression	H.265+/H.265/H.264+/H.264/MJPEG
Video Bit Rate	32 Kbps to 8 Mbps
H.264 Type	Baseline Profile/Main Profile/High Profile
H.265 Type	Baseline Profile/Main Profile/High Profile
Bit Rate Control	CBR/VBR
Scalable Video Coding (SVC)	H.264 and H.265 encoding
Region of Interest (ROI)	4 fixed regions for main stream, sub-stream, third stream, fourth stream and fifth stream
Target Cropping	Yes

Audio	
Environment Noise Filtering	Yes
Audio Compression	G.711/G.722.1/G.726/MP2L2/PCM/AAC/MP3
Audio Bit Rate	64 Kbps (G.711)/16 Kbps (G.722.1)/16 Kbps (G.726)/32 to 192 Kbps (MP2L2)/16 to 64 Kbps (AAC) /8 to 320 Kbps (MP3)
Audio Sampling Rate	8 kHz/16 kHz/32 kHz/44.1 kHz/48 kHz
Audio Type	Mono sound
Network	
Security	Password protection, complicated password, HTTPS encryption, 802.1X authentication (EAP-TLS, EAP-LEAP, EAP-MD5), watermark, IP address filter, basic and digest authentication for HTTP/HTTPS, WSSE and digest authentication for Open Network Video Interface, RTP/RTSP OVER HTTPS, Control Timeout Settings, Security Audit Log, TLS 1.2
Protocols	TCP/IP, ICMP, HTTP, HTTPS, FTP, SFTP, SRTP, DHCP, DNS, DDNS, RTP, RTSP, RTCP, PPPoE, NTP, UPnP, SMTP, SNMP, IGMP, 802.1X, QoS, IPv6, UDP, Bonjour, SSL/TLS
Network Storage	NAS (NFS, SMB/CIFS), auto network replenishment (ANR) Together with high-end Hikvision memory card, memory card encryption and health detection are supported.
Simultaneous Live View	Up to 20 channels
API	Open Network Video Interface (PROFILE S, PROFILE G, PROFILE T), ISAPI, SDK, ISUP
User/Host	Up to 32 users 3 user levels: administrator, operator, and user
Web Browser	Plug-in required live view: IE9+, Chrome 41.0 to 44, Firefox 30.0 to 51, Safari 8.0 to 11 Plug-in free live view: Chrome 45.0+, Firefox 52.0+ Not recommended: Safari 11+, Edge
Client	iVMS-4200, Hik-Connect
Image	
Image Parameters Switch	Yes
Image Settings	Saturation, brightness, contrast, sharpness, white balance, and AGC adjustable by client software or web browser
Day/Night Switch	Day, Night, Auto, Schedule, Alarm Trigger
Wide Dynamic Range (WDR)	140 dB
SNR	≥ 52 dB
Image Enhancement	BLC, HLC, Defog, 3D DNR
Privacy Mask	8 programmable polygon privacy masks, mask color or mosaic configurable
Image Stabilization	EIS
Picture Overlay	LOGO picture can be overlaid on video with 128 × 128 24bit bmp format
Interface	
Video Output	1 Vp-p Composite Output (75 Ω/CVBS) (Only for debugging)
Ethernet Interface	1 RJ45 10 M/100 M/1000 M self-adaptive Ethernet port
On-Board Storage	Built-in memory card slot, support microSD/microSDHC/microSDXC card, up to 256 GB
Audio	1 input (line in), 1 output (line out), 3.5 mm connector, 2 built-in microphones
Alarm	1 input, 1 output (max. 24 VDC, 1 A)
RS-485	With -Y: 1 RS-485 (half duplex, HIKVISION, Pelco-P, Pelco-D, self-adaptive)
Reset Key	Yes

Power Output	12 VDC, max. 100 mA
Event	
Basic Event	Motion detection, video tampering alarm, exception (network disconnected, IP address conflict, illegal login, abnormal reboot, HDD full, HDD error), video quality diagnosis, vibration detection
Smart Event	Line crossing detection, intrusion detection, region entrance detection, region exiting detection, audio exception detection, scene change detection, defocus detection
Linkage	Upload to FTP/NAS/memory card, notify surveillance center, send email, trigger alarm output, trigger recording, trigger capture
Deep Learning Function	
Multi-target-type Detection	Supports simultaneous detection and capture of human body, face and vehicle Gets 7 face features, 13 human body features and 2 vehicle features
Face Capture	1. Detects up to 60 faces simultaneously 2. Supports swing left and right from -60° to 60°, tilt up and down from -30° to 30° 3. Uploads face with background and closed-up face pictures
Face Comparison	Up to 10 face libraries. Up to 150,000 faces for each library. 150,000 faces in total. Supports face library encryption
Perimeter Protection	Line crossing, intrusion, region entrance, region exiting Support alarm triggering by specified target types (human and vehicle)
General	
Power	With -Y: 12 VDC ± 20%, 1.23 A, max. 14.7 W, three-core terminal block; 24 VAC ± 20%, 0.91 A, max. 13.7 W, three-core terminal block; PoE: 802.3at, Type 2, Class 4, 42.5 V to 57 V, 0.27 A to 0.36A, max. 15.0 W Without -Y: 12 VDC ± 20%, 1.23 A, max. 14.7 W, two-core terminal block; 24 VAC ± 20%, 0.91 A, max. 13.7 W, two-core terminal block; PoE: 802.3at, Type 2, Class 4, 42.5 V to 57 V, 0.27 A to 0.36A, max. 15.0 W
Material	Aluminum alloy body
Dimension	Ø162 × 141.8 mm (Ø6.4" × 5.6")
Package Dimension	251 × 215 × 189 mm (9.9" × 8.5" × 7.4")
Weight	Without -Y: approx. 1490 g (3.28 lb.) With -Y: approx. 1565 g (3.45 lb.)
With Package Weight	Without -Y: approx. 2435 g (5.37 lb.) With -Y: approx. 2295 g (5.06 lb.)
Storage Conditions	-30 °C to 60 °C (-22 °F to 140 °F). Humidity 95% or less (non-condensing)
Startup and Operating Conditions	-40 °C to 60 °C (-40 °F to 140 °F). Humidity 95% or less (non-condensing)
Language	33 languages: English, Russian, Estonian, Bulgarian, Hungarian, Greek, German, Italian, Czech, Slovak, French, Polish, Dutch, Portuguese, Spanish, Romanian, Danish, Swedish, Norwegian, Finnish, Croatian, Slovenian, Serbian, Turkish, Korean, Traditional Chinese, Thai, Vietnamese, Japanese, Latvian, Lithuanian, Portuguese (Brazil), Ukrainian
General Function	Heartbeat, mirror, password protection, watermark, privacy mask, IP address filter, one-key reset, five streams
Heater	Yes

Approval

EMC	FCC (47 CFR Part 15, Subpart B); CE-EMC (EN 55032: 2015, EN 61000-3-2:2019, EN 61000-3-3:2013+A1:2019, EN 50130-4: 2011 +A1: 2014); RCM (AS/NZS CISPR 32: 2015); IC (ICES-003: Issue 7); KC (KN 32: 2015, KN 35: 2015)
Safety	UL (UL 62368-1); CB (IEC 62368-1:2014+A11); CE-LVD (EN 62368-1:2014/A11:2017); BIS (IS 13252(Part 1):2010/IEC 60950-1 : 2005); LOA (IEC/EN 60950-1)
Environment	CE-RoHS (2011/65/EU); WEEE (2012/19/EU); Reach (Regulation (EC) No 1907/2006)
Protection	IK10 (IEC 62262:2002), IP67 (IEC 60529-2013)
Anti-Corrosion Protection	With -Y: NEMA 4X (NEMA 250-2018)
Automotive and Railway	EN50121-4
Other	PVC FREE

Dimension

Without -Y:

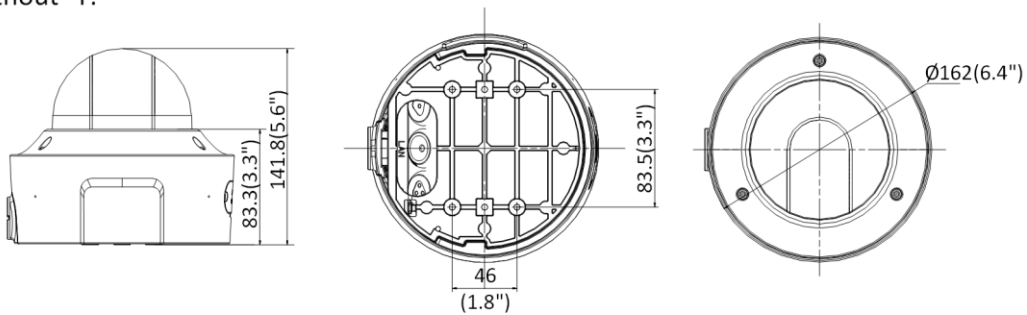



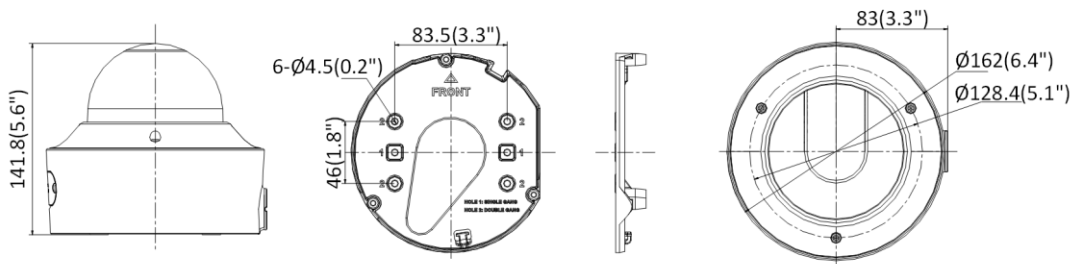

With -Y:



Unit: mm (inch)

▪ Accessory

▪ Optional

Wall Mount	Pendant Mount	Vertical Pole Mount	Corner Mount	Wall Mount
				
Corner Mount	In-Ceiling Mount	Vertical Pole Mount	Pendant Mount	Wall Mount
