

100W UFO HIGHBAY

140PCS SANAN 2835MIL, 100LM/W

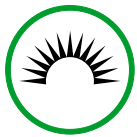

Lumens
100Lm/W

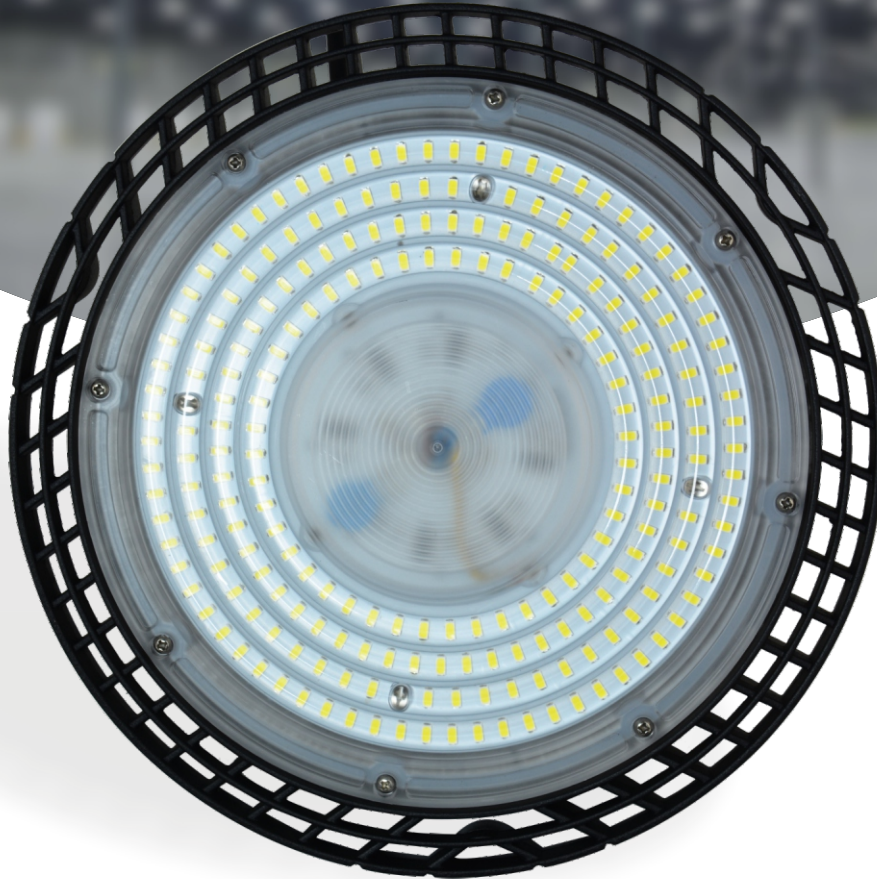

Wattage
100W

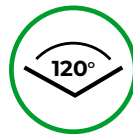

Beam
Angle 120°



IP Rating



Suitable for
lighting in warehouses,
garages, factory workshops,
supermarkets, basements,
exhibition halls, gyms etc.

Product Features

Transform your commercial lighting using our incredible UFO LED High Bay Light, offering an energy-efficient, low maintenance lighting solution for any large commercial area.

The light is distributed at a 120° beam angle, making it suitable for both high and low bay use. It also comes with an IP65 rating, guarding it against splashes of water and foreign objects larger than 1mm and giving you additional peace of mind.

Depending on where you're planning on using this product, you'll get to choose whether you would like day light (4000K) or cool white (6000K) light.

SKU	EAN	Colour Temp.
T361	5060774552650	6500K
T362	5060774552667	4000K

Technical Specification:

Model No.	: SL2-3-100W
Housing colour	: Black
LED Light Source	: SANAN SMD 2835
Input Voltage (V)	: AC185-265V
Lamp Power (W)	: 100W
IP Rating	: IP65,
Led Luminous Efficiency (lm/w)	: 100LM/W
CRI (Ra>)	: 70
Colour Temperature (CCT)	: 4000-6500K
Beam Angle (°)	: 120
Working Temperature (°C)	: -20-40
Led Working Lifetime (Hour)	: ≥30000
Projection distance	: 12-24M
Output cable	: 1 Meter
Body size	: 595*595*15MM

Size Diagram

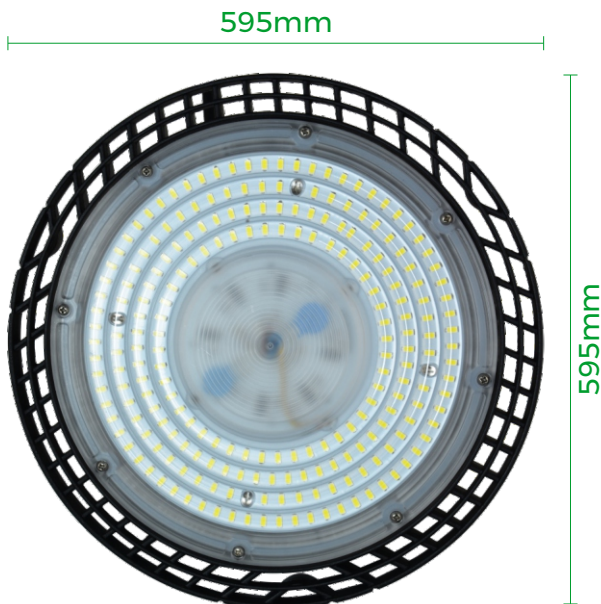

Luminous Intensity Distribution Diagram

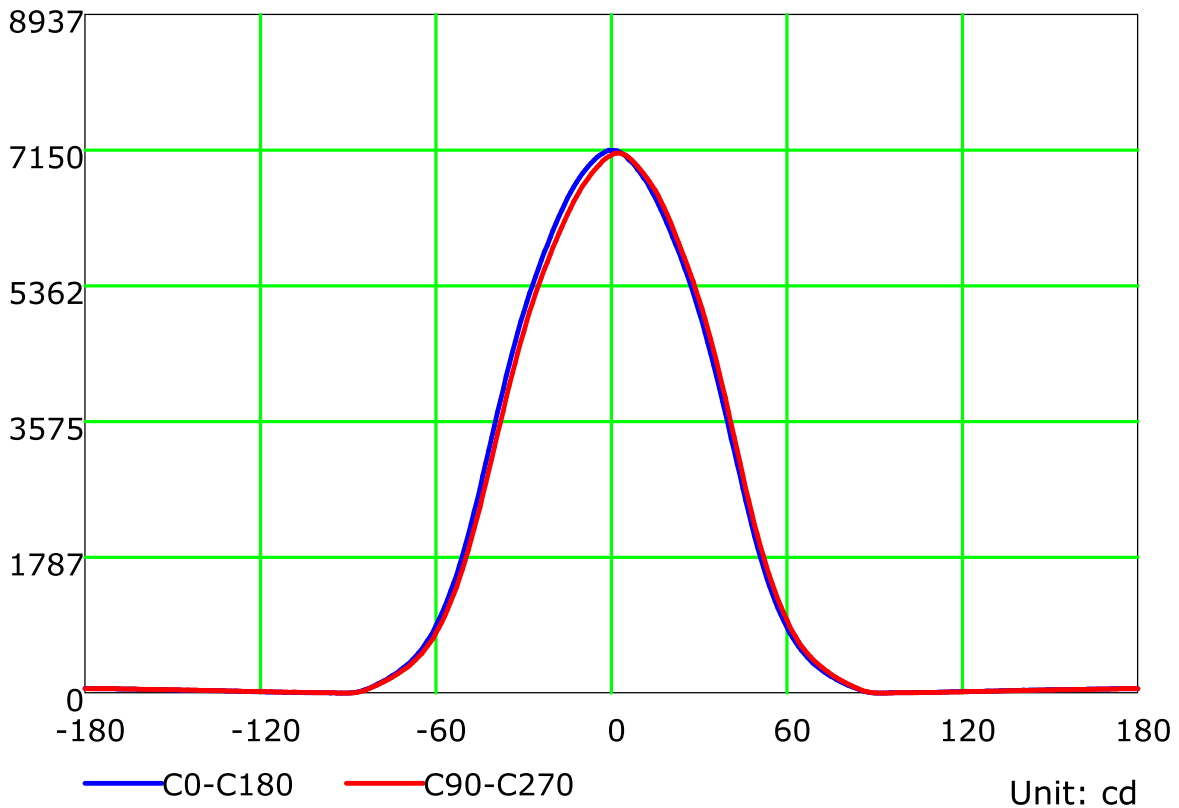
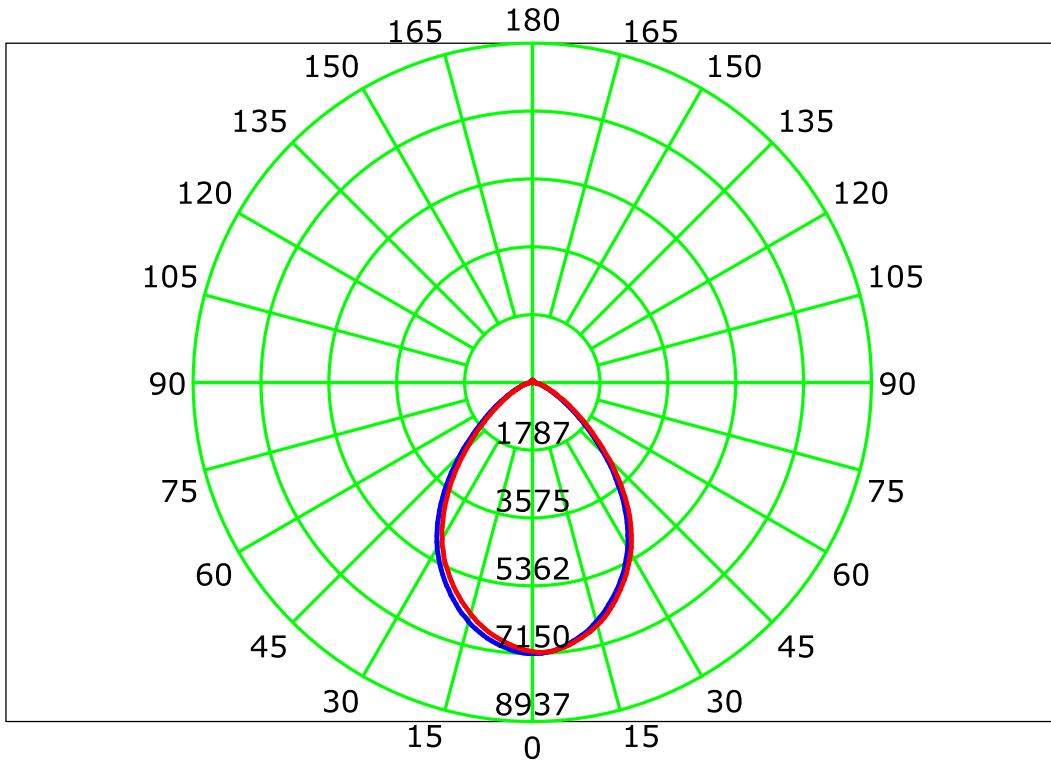

C Plane (°):0.0-360.0: 45.0
 Test Lab:
 Test Type: TYPE C
 Temperature:
 Operator: admin

Gamma Plane (°):0.0-180.0:1.0
 Test Device: GPM-1600L
 Distance: 6.429 m
 Humidity:
 Inspector:

IsoLux Plot

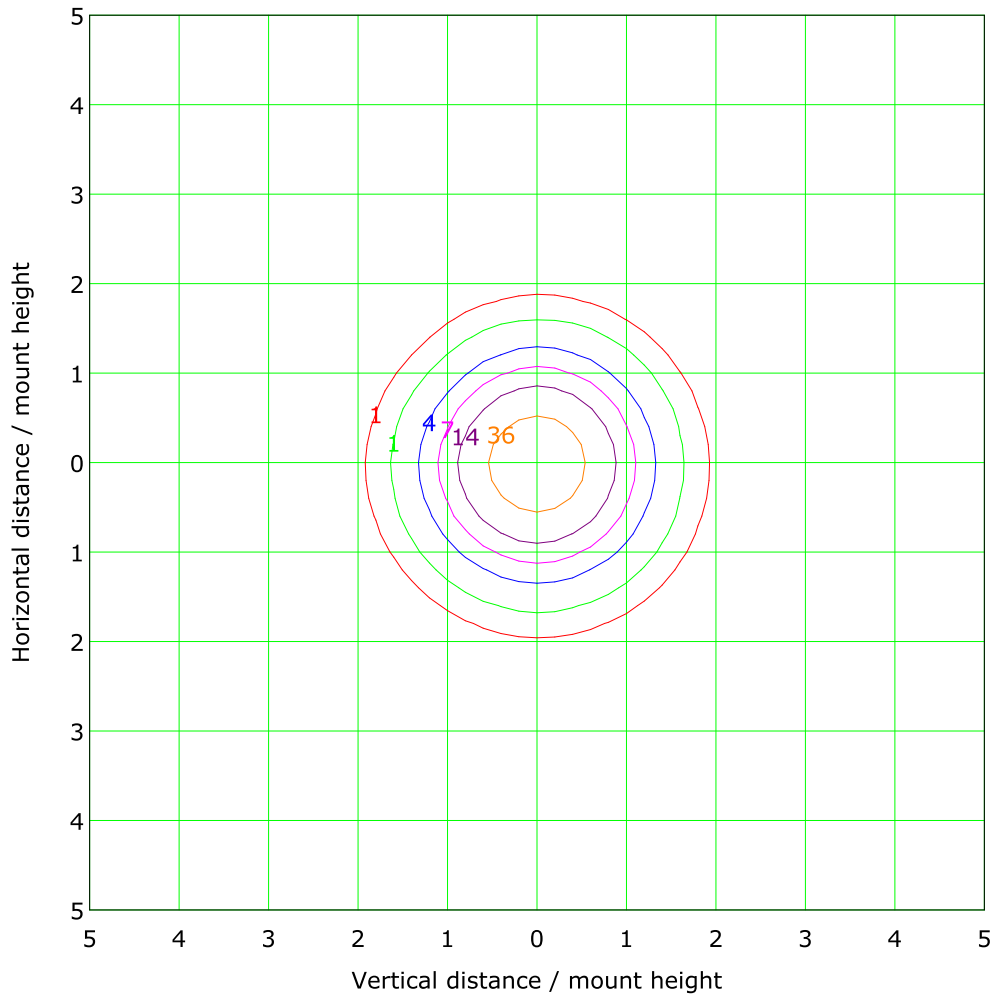

Mounting Height: 10.0m Max Lux(100%): 71.5 lx	
— (1%): 0.7 lx	— (2%): 1.4 lx
— (5%): 3.6 lx	— (10%): 7.1 lx
— (20%): 14.3 lx	— (50%): 35.7 lx
— (100%): 71.5 lx	

C Plane (°):0.0-360.0: 45.0
 Test Lab:
 Test Type: TYPE C
 Temperature:
 Operator: admin

Gamma Plane (°):0.0-180.0:1.0
 Test Device: GPM-1600L
 Distance: 6.429 m
 Humidity:
 Inspector:

Thank you for choosing ENER-J!

Customer satisfaction is our TOP priority, please let us know how you felt about your experience. Happy? We are so happy that you are pleased with our product. Feel free to express your newfound joy! Share your experience by writing a review.

Not Happy? If you are not fully satisfied with the item you received, have any problems like damages, or questions, please contact us. We typically respond within 24-48 hours.

Stuck? Confused?

Contact our Technical Support team on:
 T: +44 (0)1291446105 | E: support@ener-j.co.uk
 Lines are open Mon - Fri (8am to 4pm)